

Date rev. Description

V 1.0

House	4.4.74.081 München 5 ISO	Sheet	1
Drawing	3D	Scale	
Material	4.4.X135	Date	12.12.2023
Drawer	K.K.	File	4.4.74.081 München 5 ISO 3D.dwg

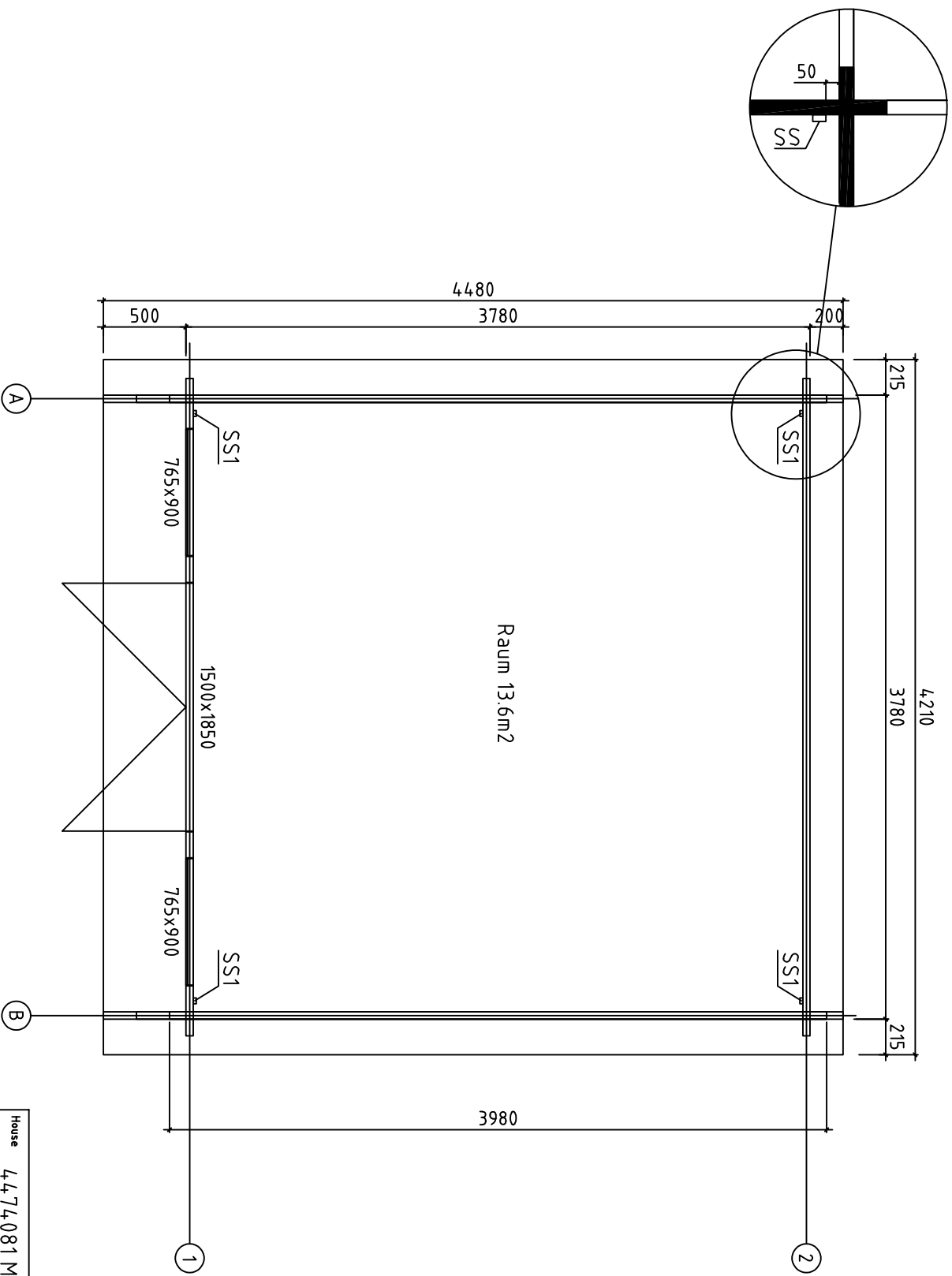

House	44.74.081 München 5 ISO	Sheet	2
Drawing	Plan	Scale	1:35
Material	44.X135	Date	12.12.2023
Drawer	K.K.	File	44.74.081 München 5 ISO.dwg

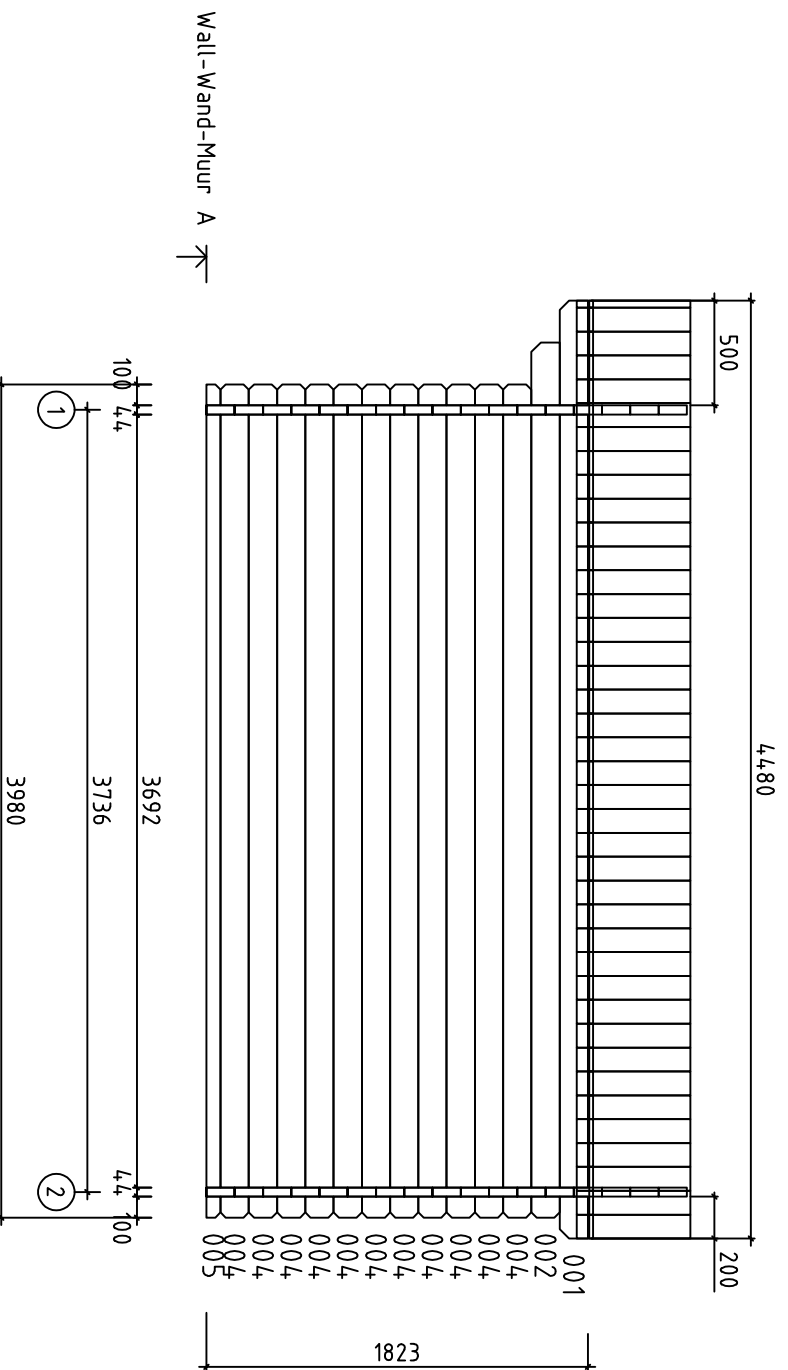

House	44.74.081 München 5 ISO	Sheet	3
Drawing	WALL - WAND - MUUR A	Scale	1:35
Material	4.4x13.5	Date	12.12.2023
Drawer	K.K.	File	44.74.081 München 5 ISO.dwg

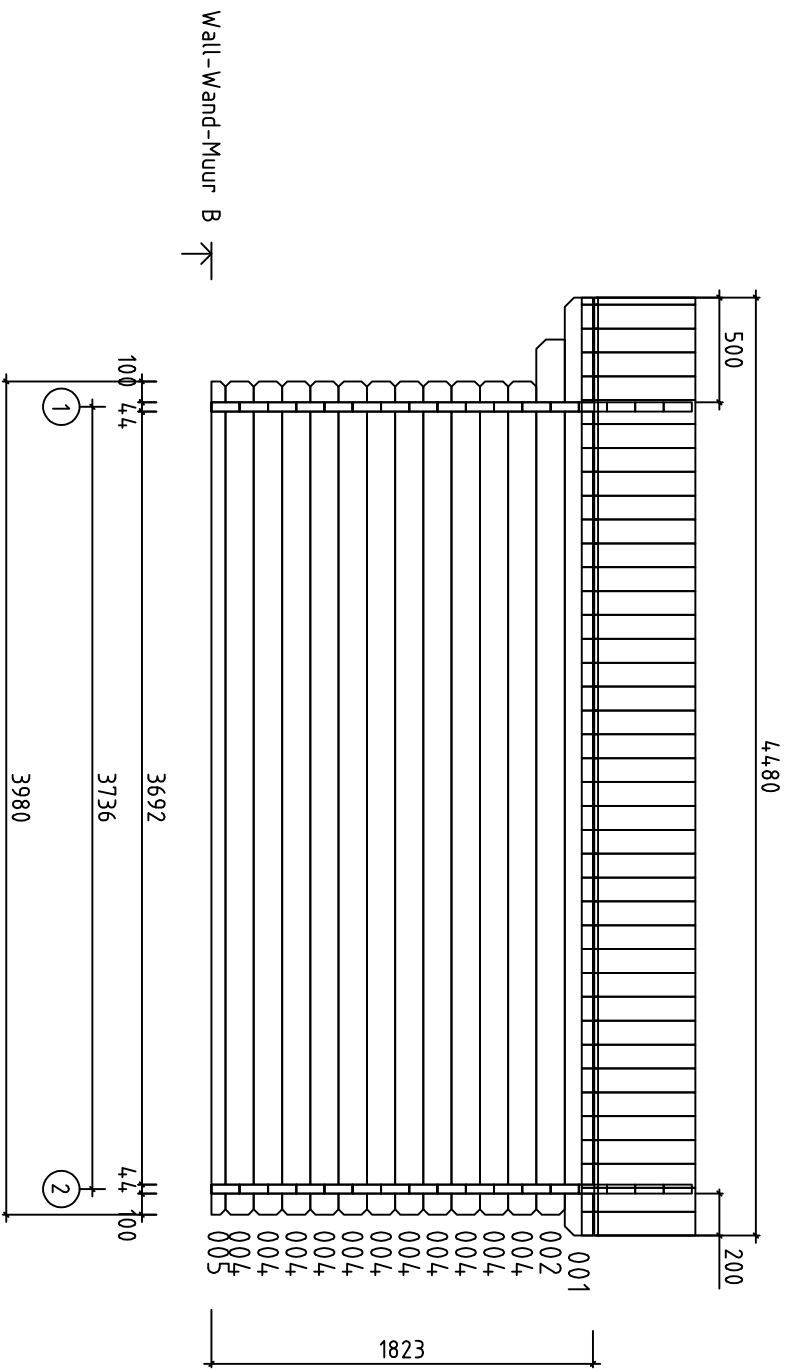



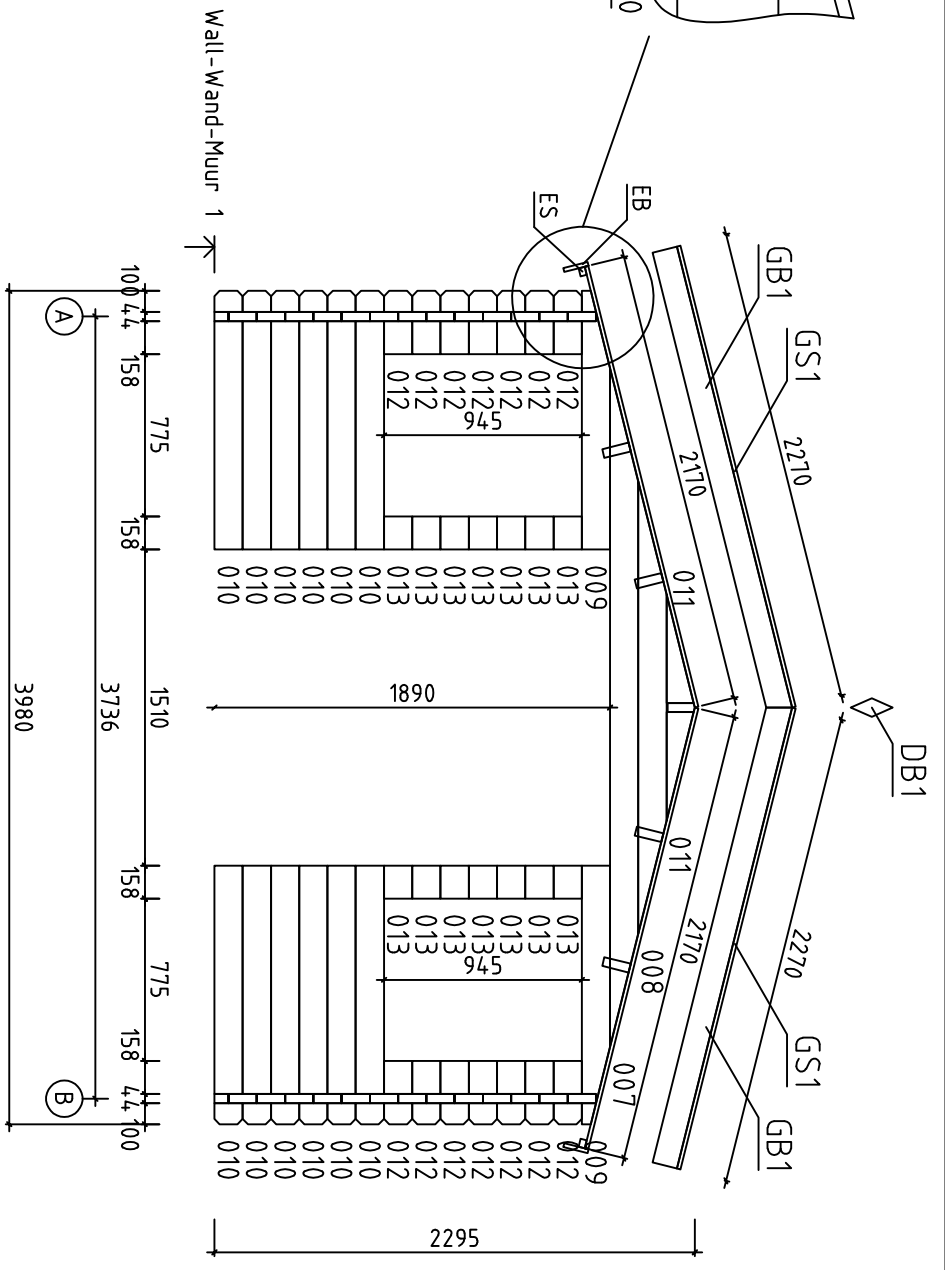
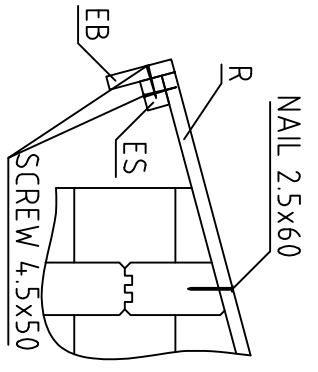





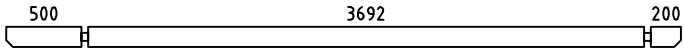
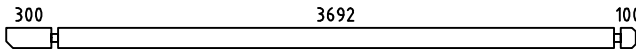
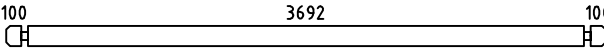
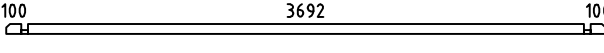
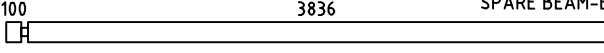
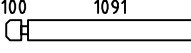

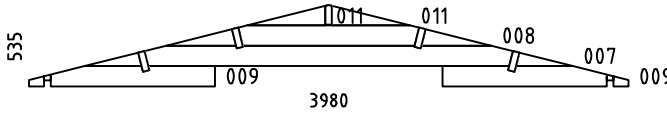
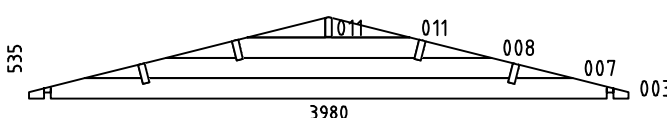

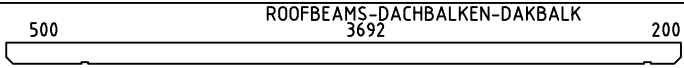
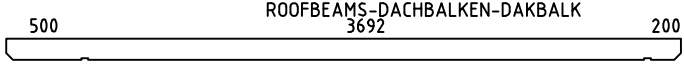

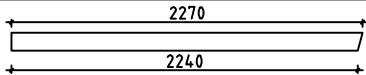

House	44.74.081 München 5 ISO	Sheet	4
Drawing	WALL - WAND - MUUR B	Scale	1:35
Material	4.4x13.5	Date	12.12.2023
Drawer	K.K.	File	44.74.081 München 5 ISO.dwg



House	44.74.081 München 5 ISO	Sheet	5
Drawing	WALL - WAND - MUUR 1	Scale	1:35
Material	4.4x13.5	Date	12.12.2023
Drawer	K.K.	File	44.74.081 München 5 ISO.dwg

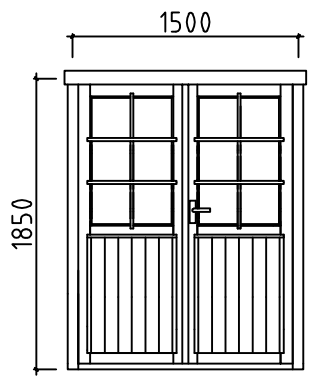
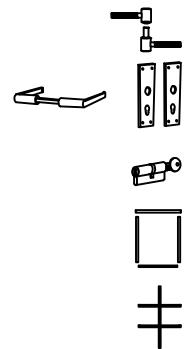
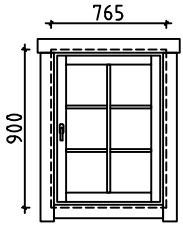
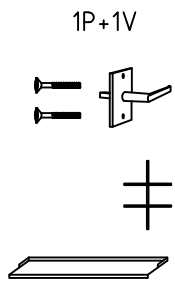

Pos	Specification-Bestimmung-Omschrijving	Pcs	Profile (mm)	L (mm)		
001	 PM	2	44x135	4480		
002	 2	2	44x135	4180		
004	 35	35	44x135	3980		
005	 2	2	44x68	3980		
006	 SPARE BEAM-ERZATZBOHLE-VOORRAADPLANK	1	44x135	3980		
010	 12	12	44x135	1235		
012	 14	14	44x135	302		
013	 14	14	44x135	158		
W1-1	 1	1	44x535	3980		
W2-1	 1	1	44x535	3980		
HB	HIT BLOCK-SCHLAGHÖLZER-BLAZENPLANK 	2	44x135	300		
RB1	 ROOFBEAMS-DACHBALKEN-DAKBALK	4	43x140	4480		
RB2	 ROOFBEAMS-DACHBALKEN-DAKBALK	1	43x140	4480		
R1	ROOFBOARD-DACHBRETT-DAKPLANK  or-oder-of	104+2 80+2	18x88 18x114	2170		
GB1	GABLE BOARD-GIEBELBLENDE-GEVELPLANK 	4	18x120	2270		
GS1	ROOF FELT FILLET-GIEBELLEISTE-GEVELLIJST 	4	18x70	2270		
EB1	EAVE BOARD-TRAUFBRETT-AFDEKPLANK 	4	18x90	2240		
ES1	EAVE SLAT-TRAUFFENLEISTE-AFDEKLIJST 	4	30x40	2240		
DB1	DIAMOND-RAUTE-DIAMANT 	2	18x90	200		
SS1	STORM SLAT-STURMLEISTE-STORMLIJST 	4	18x35	1770		
	SCREWS-SCHRAUBEN-SCHROEF FOR-FÜR-VOOR SS1 	12	φ6.0	50		
	WASHER-SCHEIBE-SCHIJF FOR-FÜR-VOOR SS1 	12	φ6.0	18		
	NAIL-NAGEL-NAGEL FOR-FÜR-VOOR R1 	456	φ2.5	60		
Kood	4474081 München 5 ISO	Materjal	File	4474081 München 5 ISO.dwg	Leht	7

Pos	Specification-Bestimmung-Omschrijving	Pcs	Profile (mm)	L (mm)
	SCREWS-SCHRAUBEN-SCHROEF FOR-FÜR-VOOR GB1, GS1, EB1, ES1, DB1 	90	ø4.5	50
	SCREWS-SCHRAUBEN-SCHROEF FOR-FÜR-VOOR RB1, RB2 	10	ø6.0	160
	DOUBLEDOR-DOPPELTÜR-DUBBELE DEUR (right-rechts-rechts) AST __ISO__PL p.p.  	1	1500	1850
	WINDOW-FENSTER-VENSTER (1x right-rechts-rechts; 1x left-links-links) AST_PRE  	2	765	900